



PST – Polygon Shank Taper ISO 26623

Das Werkzeugsystem mit powRgrip® für angetriebene Werkzeuge mit ISO 26623 kompatibler Schnittstelle.

The tooling system with powRgrip® for driven tools with ISO 26623 compatible interface.

powRgrip® Spannzangenadapter powRgrip® collet chuck adapter

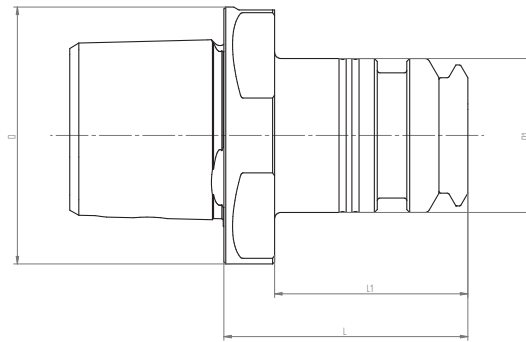

Abmessungen / Dimensions [mm]

Typ/Type	Art.-Nr./Part no.	D	D1	d min.	d max.	L	L1
powRgrip® PST Adapter ISO 26623							
PST 3/PGST 15x038	2803.71500	32	24	3	10	38	32,0
PST 4/PGST 15x038	2804.71500	40	24	3	10	38	30,1

powRgrip® Spannzangen Typ PGST powRgrip® collets type PGST

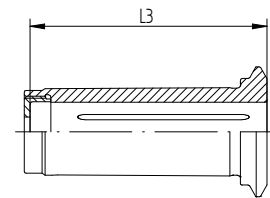
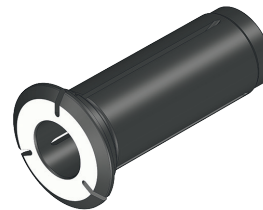

Typ/Type	Art.-Nr./Part no.	L3 [mm]
PGST 15 [mm]		
Ø 3,0 mm	1715.03006	28
Ø 4,0 mm	1715.04006	28
Ø 6,0 mm	1715.06006	36
Ø 8,0 mm	1715.08006	36
Ø 10,0 mm	1715.10006	40

Typ/Type	Art.-Nr./Part no.	L3 [mm]
PGST 15 [inch]		
Ø 1/8"	1715.03186	28
Ø 3/16"	1715.04766	28
Ø 1/4"	1715.06356	36
Ø 5/16"	1715.07946	36
Ø 3/8"	1715.09526	40

REGO-FIX powRgrip®

EINFACH / SIMPLE

Werkzeug per Knopfdruck in 8 Sekunden gespannt
Tool is clamped in 8 seconds by pushing one single button

SICHER / SAFE

Keine Hitzeentwicklung – Hohe Spannkraft
No heat – high clamping force

powRgrip®

Das Werkzeugspannsystem für heute und morgen
The tool clamping system of today and tomorrow



Schneidwerkzeug
Cutting tool



REGO-FIX powRgrip® Spannzange
REGO-FIX powRgrip® collet



PST Adapter für powRgrip®
PST adapter for powRgrip®

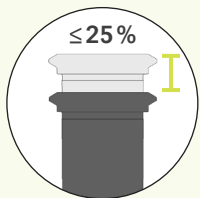

PGST ist bis zu 25% kürzer als das konventionelle PG-System. Normschäfte können vollständig eingesteckt werden.

PGST is up to 25% shorter than conventional PG. Norm shafts can be fully inserted.

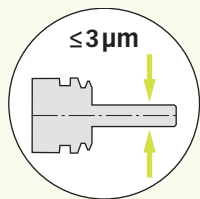

Gesamtsystemrundlauf
≤ 3 μm bei 3 x D.

Total system runout TIR ≤ 3 μm at 3 x D.

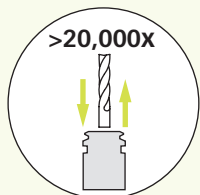

Höchste Haltekraft und Rundlaufgenauigkeit auch nach 20'000-fachem Werkzeugwechsel.

Maximum clamping force and low runout, even after 20,000 tool changes.

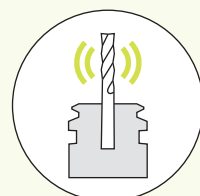

Hervorragende Vibrationsdämpfung.

Excellent vibration dampening.





REGO-FIX 
www.rego-fix.com

REGO-FIX AG

Obermattweg 60
4456 Tenniken
Switzerland
info@rego-fix.com